

DENAFRIPS

HERMES DDC

OWNER'S MANUAL

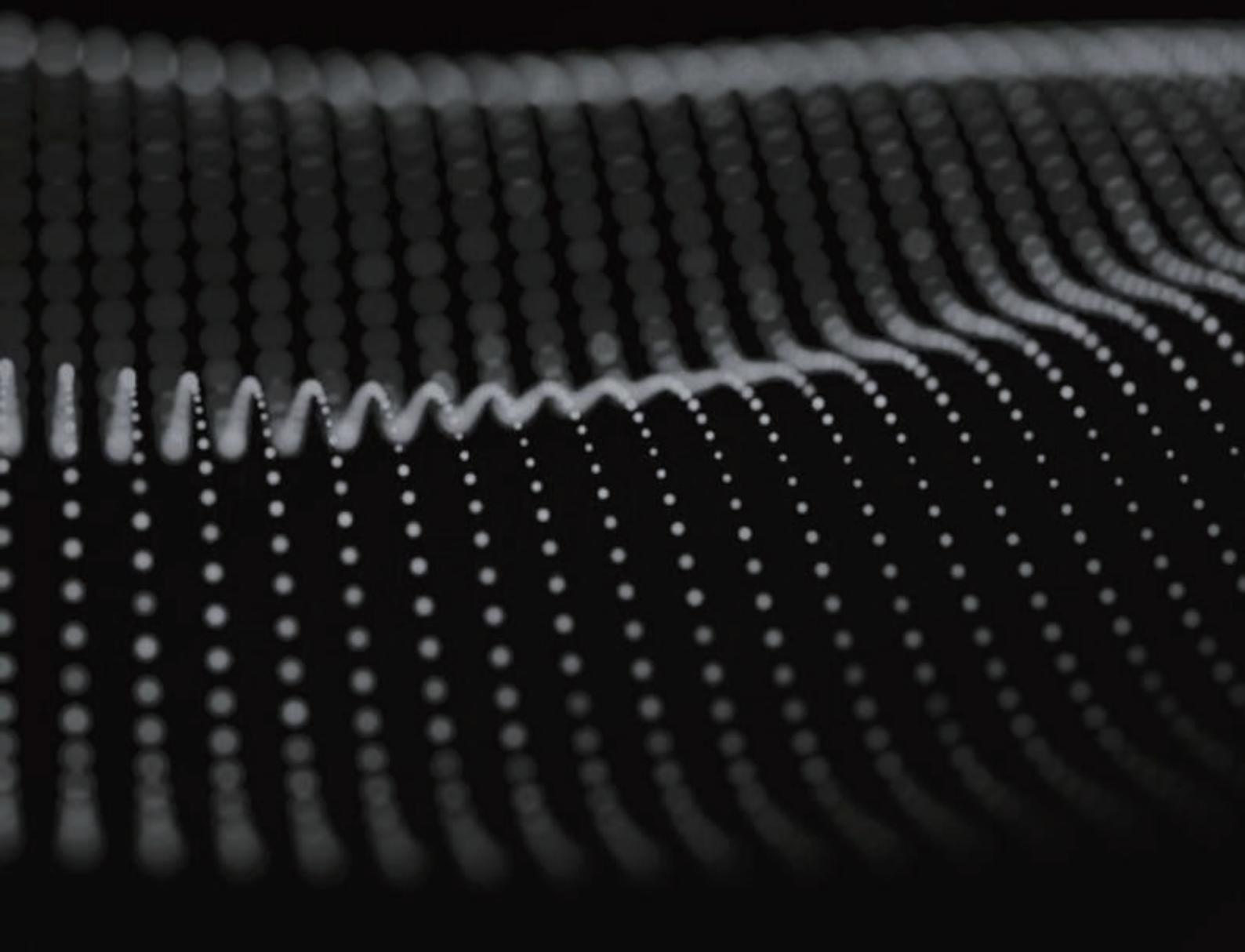

INSTALLATION & SAFETY INSTRUCTIONS

Contents

1. INSTALLATION & SAFETY INSTRUCTIONS	3
2. INTRODUCTION	5
3. DESIGN HIGHLIGHTS	6
3.1 DIGITAL ISOLATION	6
3.2 OVEN-CONTROLLED CRYSTAL OSCILLATOR – OCXO	6
3.3 ADAPTIVE FIFO BUFFER RECLOCKING	6
3.4 PROPRIETARY, STATE-OF-THE-ART USB INTERFACE.....	7
3.5 PROPRIETARY SPDIF DIGITAL AUDIO RECEIVER.....	7
3.6 DDC ARCHITECTURE.....	8
3.7 CLOCK IN.....	8
4. OPERATING INSTRUCTION	9
4.1 Quick Start Guide.....	9
4.2 USB DRIVER INSTALLATION – WINDOWS OS	21
5. SPECIFICATIONS	26
6. After-Sales Service	28

INSTALLATION & SAFETY INSTRUCTIONS

This DDC is designed and built to provide trouble-free performance, but as with all electronic devices it is necessary to observe a few precautions:

1. Unpack the HERMES DDC carefully.
2. Position the DDC on a stable, horizontal surface, i.e. sturdy rack.
3. The DDC supports voltage 115–230VAC worldwide voltage. Please connect the AC power cord with earth(ground) pin unless it is absolutely required to reduce hum from the ground loops of the connected devices.
4. Always ensure that when disconnecting and reconnecting your audio equipment the mains supply is turned off.
5. Position the power cord and signal interconnects where they are not likely cause trip and fall hazard.
6. Do not use the Equipment near water, or place water-filled containers on the Equipment. Entry of liquid into the Equipment is hazardous and may cause electric shock and/or fire hazard.
7. Do not place the unit under direct sunlight or heat source.
8. Do not remove any covers or try to gain access to the inside. There are no user adjustments or fuses to change without qualification.

INSTALLATION & SAFETY INSTRUCTIONS

9. Clean regularly with a damp soft cloth. Do not use any cleaning agents as it might damage the surface finishing.
10. The electronics in modern hi-fi equipment is complex and may, therefore, be adversely affected or damaged by lightning. For protection of the audio system during electrical storms, disconnect the mains plugs.

INTRODUCTION

Thank you for purchasing the DENAFRIPS HERMES DDC. It is a state-of-the-art Digital to Digital Converter, one of the finest available on the market.

The flagship DDC, built upon the success of the DENAFRIPS Digital Know-How. HERMES DDC isolates and buffers the digital signal, re-clock them via the local OCXO. The cleansed, ultra low jitters digital output can be connected to any external DAC. It is the answer to the Digital Audio System. The top-quality performance of the HERMES DDC is for the serious audiophile who seek the very last bit of ultimate refinement.



DESIGN HIGHLIGHTS

3.1 DIGITAL ISOLATION

The HERMES Digital Signals are completely isolated by the 50-Mbps high speed photocouplers. The optical isolation yields even lowered noise-floor and achieved high signal to noise ratio.

3.2 OVEN-CONTROLLED CRYSTAL OSCILLATOR-OCXO

The HERMES is equipped with dual OCXO operating at audio frequencies 45.1584MHz, 49.152MHz. Encapsulated in a metal casing, located at the centre of the DDC, these OCXO are specially designed for high-end audio applications with ultra-low phase-noise and ultraaccuracy. The dual OCXO are powered by the o-core transformer, supplying constant current to the OCXO. The adequate power reserves ensure the superior linearity and stability of the OCXO.

3.3 ADAPTIVE FIFO BUFFER RECLOCKING

The DENAFRIPS approach to address the jitters issue by FIFO BUFFER RECLOCKING. The adaptive FIFO buffer store the source digital audio data in the memory. These data are read from the memory using the ultra-low phase noise, ultra-accuracy OCXO, located right in the DDC.

This technology is close to the perfection, especially so with the local OCXO. The jitter is so small that it can be neglected.

DESIGN HIGHLIGHTS

3.4 PROPRIETARY, STATE-OF-THE-ART USB INTERFACE

The HERMES is equipped with the proprietary USB Audio Solution, powered by STM32F446 Advanced AMR Based MCU. DENAFRIPS redesigned and optimized circuitry, allow the DDC to be used as high-end DDC with computers / streamers. It supports 24bit/768kHz PCM data stream, and native processing of DSD up to DSD512. It comes with licensed THESYCON USB Driver for Windows Platform.

NOTE: The USB Module is designed to trigger on only when USB Input is selected. This is intended design to reduce digital input interfaces cross-interference for best sound reproduction.

3.5 PROPRIETARY SPDIF DIGITAL AUDIO RECEIVER

The SPDIF Coaxial, Optical, AES/EBU input support up to 24bit/192kHz digital audio format. The HERMES abandon the use of Digital Audio Receiver chip. The digital data is decoded by the on-board FPGA (Field Programmable Gate Array), signal path is shortened and eliminated the undesirable coloration.

DESIGN HIGHLIGHTS

3.6 DDC ARCHITECTURE

DIGITAL SIGNAL PROCESSING — All digital input data are stored in the on-board FPGA high speed RAM.

OCXO — These data are read from the memory using the ultra-low phase noise, super accurate OCXO, located right in the DDC. The processed data are sent to the digital outputs.

DIGITAL OUTPUTS — The cleansed, ultra-low jitters data are output via multiple digital output interfaces simultaneously to the external DAC.

3.7 CLOCK IN

The HERMES supports clock in of audio frequencies 45.1584MHz, 49.152MHz. It makes a perfect companion with the TERMINATOR 15TH or TERMINATOR-PLUS 15TH to synchronize the CLOCKS.

OPERATING INSTRUCTION

4.1 Quick Start Guide



Figure 1. Front Panel

(1) Standby Button

Press the setup button once to enter configuration mode. In configuration mode, user may enable/disable the CLOCK-IN feature.

- Press Setup button once (enter config mode)
- Press OPT button twice
- CLOCK light should be on/off as the OPT button is pressed momentarily
- CLOCK light on = Enable clock in
- CLOCK light off = Disable clock in
- To confirm the setting, press Setup button once to save and exit config mode

OPERATING INSTRUCTION

4.1 Quick Start Guide



Figure 1. Front Panel

(2) Input Selection Button

Press the following button to select the desire input to use with the HERMES DDC.

- a. USB
- b. OPT
- c. AES
- d. COAX

OPERATING INSTRUCTION

1. LED light indication	
COAX lamp	<p>According to the change of sound source keys.</p> <p>Lights out: the sound source is not selected.</p> <p>Light on: the sound source has been selected.</p>
AES1 lamp	
OPT lamp	
USB lamp	
CLOCK lamp	Lights out: internal clock has been selected.
	Lights on: external clock has been selected.
44K1 88.2K 176.4K 352.8K 705.6K 64 128 256 512 1024 48K 96K 192K 384K 768K	<p>According to the sampling rate of the input signal.</p> <p>Lights out: the input signal is not at this sampling rate.</p> <p>Lights on: the input signal is at this sampling rate.</p>
DSD lamp	Lights out: PCM audio
	Lights on: DSD audio

OPERATING INSTRUCTION

(3) Digital Audio Signal Input Sampling Rate

The following table illustrate the Input Sampling Rate LED status.

Base Sampling Rate	Indicator	Input Format
44.1 KHz	44.1K	44.1 KHz
	88.2K	88.2 KHz
	176.4K	176.4 KHz
	352.8K	352.8 KHz
	705.6K	705.6 KHz
48 KHz	48K	48 KHz
	96K	96 KHz
	192K	192 KHz
	384K	384 KHz
	768K	768 KHz
DSD	64	DSD 64
	128	DSD 128
	256	DSD 256
	512	DSD 512
	1024	DSD 1024

Table 1. Sampling Rate

OPERATING INSTRUCTION



Figure 2. Read Panel

Description:

(1) AC Power Supply

CAUTION! HERMES supports worldwide AC mains, range from 115–230VAC. The Please use a good quality power cord with earth/ground pin connected.

(2) Digital Input Interface

There are 4 Digital Input Interfaces, namely, COAX, AES/EBU, OPT, USB.

(3) Digital Output Interface

There are 6 Digital Output Interfaces, namely, COAX, AES1, AES2, OPT, I2S–A, I2S–C. All outputs are active simultaneously. (When operating in dual AES mode, perform the dual AES configuration)

OPERATING INSTRUCTION

Parameter Settings:

(1) I2S Pinout Configuration

1. Press the Setup button once to enter configuration mode
2. Press the COAX button momentarily, 48K 96K 192K LED will turn on/off in a fixed pattern to denote binary 000–111
3. Press the Setup button once to confirm the setting and exit configuration mode

	LED			I2S PINOUT						
	48K	96K	192K	PIN	DATA		BCK		LRCK	
MODE	DATA	BCK	LRCK	MODE	1	3	4	6	7	9
0	0	0	0	0	DATA-	DATA+	BCK+	BCK-	LRCK-	LRCK+
1	1	0	0	1	DATA+	DATA-	BCK+	BCK-	LRCK-	LRCK+
2	0	1	0	2	DATA-	DATA+	BCK-	BCK+	LRCK-	LRCK+
3	1	1	0	3	DATA+	DATA-	BCK-	BCK+	LRCK-	LRCK+
4	0	0	1	4	DATA-	DATA+	BCK+	BCK-	LRCK+	LRCK-
5	1	0	1	5	DATA+	DATA-	BCK+	BCK-	LRCK+	LRCK-
6	0	1	1	6	DATA-	DATA+	BCK-	BCK+	LRCK+	LRCK-
7	1	1	1	7	DATA+	DATA-	BCK-	BCK+	LRCK+	LRCK-

Table 2. I2S PINOUT CONFIGURATION

OPERATING INSTRUCTION

I2S-A HDMI (LVDS)

I2S-C RJ45 (LVCMOS)

I2S-A I2S(HDMI端子)

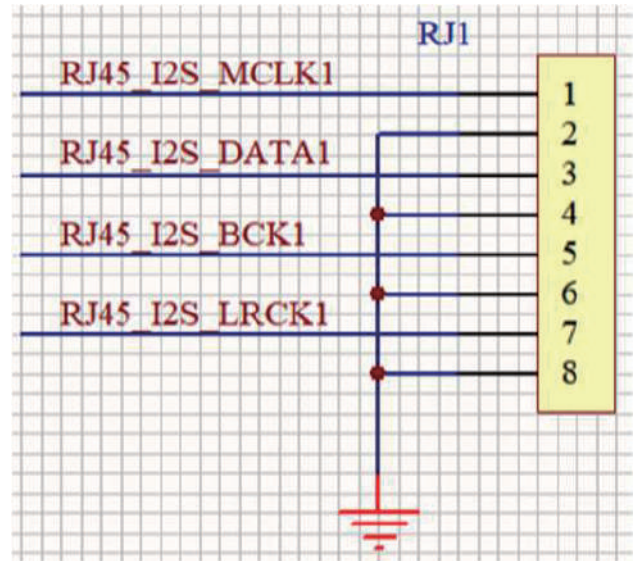
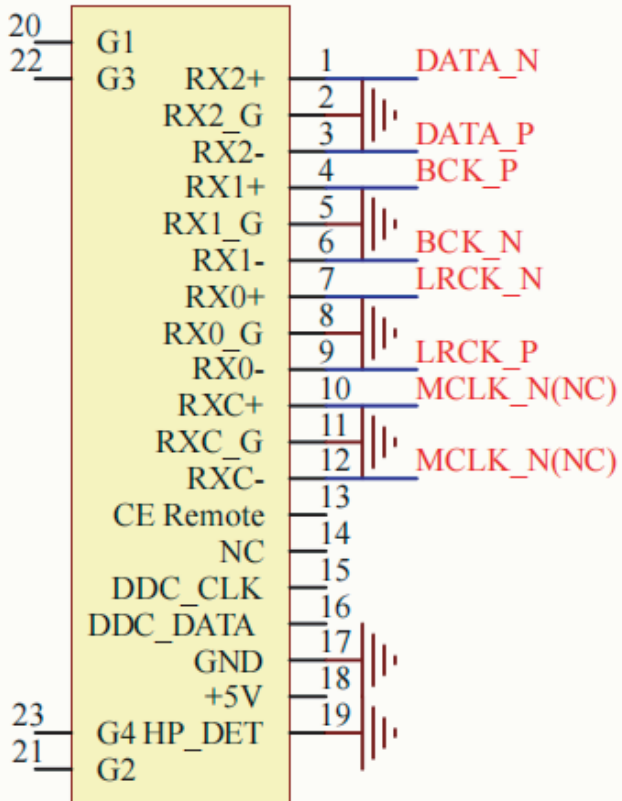

OPERATING INSTRUCTION

2. key description

SETUP key	<p>In Home Mode: Press the key to enter the menu mode.</p> <p>In menu mode: exit setup mode.</p> <p>In function setting: exit setting mode.</p>
USB key	<p>In home mode: press the key to select USB audio source.</p> <p>In menu mode: press the key to enter USB upgrade function mode.</p> <p>In function setting: press the key once to confirm entering the state to be upgraded.</p>
AES key	<p>In home mode: press the key to select AES sound source.</p> <p>In menu mode: press the key to enter the single/dual AES setting mode.</p> <p>In the function setting: press the key to switch the single/dual AES mode.</p>

OPERATING INSTRUCTION

2. key description

OPT key	<p>In home mode: press the key to select OPT audio source.</p> <p>In menu mode: press the key to enter the clock switching setting mode.</p> <p>In function setting: press the key to switch the internal and external clocks.</p>
COAX key	<p>In home mode: press the key to select COAX audio source.</p> <p>In menu mode: press the key to enter the I2S pin phase setting mode.</p> <p>In the function setting: press the key to switch the I2S phase mode.</p>

OPERATING INSTRUCTION

3. Description of function settings

	Key operation	LED light indication
I2S pin function setting The key sequence is: SETUP->COAX->COAX->COAX...	Press the SETUP button + COAX button first.	COAX lights flashing + 44.1K lights on +88.2K lights on +176.4K lights on.
	Then press the COAX button to switch.	48K(DATA), 96K(BCK) and 192K(LRCK) lights are turned off as positive. The lights of 48K(DATA), 96K(BCK) and 192K(LRCK) are negative.
DSD left and right channel function settings The key sequence is: SETUP->COAX->OPT->OPT...	Press the SETUP button + COAX button first.	COAX lights flashing + 44.1K lights on +88.2K lights on +176.4K lights on.
	Press OPT button again to switch.	COAX light flashing + 44.1K light on +88.2K light on +176.4K light on +768K light on: L/R COAX light flashing +44.1K light on +88.2K light on +176.4K light on +705.8K light on: R/L
USB upgrade function settings The key sequence is:SETUP->USB->USB	Press the SETUP button + USB button first.	COAX light flashing +USB light flashing
	Press the SETUP button + COAX button first.	COAX light flashing +USB light flashing

OPERATING INSTRUCTION

3. Description of function settings

	Key operation	LED light indication
Dual AES function setting The key sequence is: SETUP→AES →AES...	Press the SETUP button + AES button first.	COAX light flashing +AES light flashing
	Then press AES button to switch.	COAX light flashing +AES light flashing
Internal clock/ external clock function setting The key sequence is:SETUP→OPT →OPT...	Press MUTE +OPT first.	COAX light flashing +OPT light flashing
	Press the OPT button again to switch.	CLOCK light on +COAX light flashing +OPT light flashing: external clock. CLOCK off +COAX flashing +OPT flashing: internal clock.
memory function	After modifying the function settings, stop the key operation for more than 12 seconds, and then check the memory function after power-off and power-on. Except USB upgrade function settings, other function settings need to check the memory function.	

OPERATING INSTRUCTION

4.2 USB DRIVER INSTALLATION –WINDOWS OS

USB driver is required for Windows Operating System (Windows 7/8/8.1/10, X86/X64). The USB driver is licensed by THESYCON to provide the highest quality audio playback for Computer Audio System.

NOTE: Mac and Linux OS do not require the USB driver.

Installation Guide:

- 1.Download the driver from the support page:
<https://www.denafrips.com/support>
- 2.Do not connect the USB cable from the computer to the DDC. Remove it before the USB driver installation
- 3.Double click the “DENAFRIPS_UsbAudio_v4.82.0” (or the latest version) to install the USB driver.
- 4.Follow the on–screen instruction to complete the installation

OPERATING INSTRUCTION

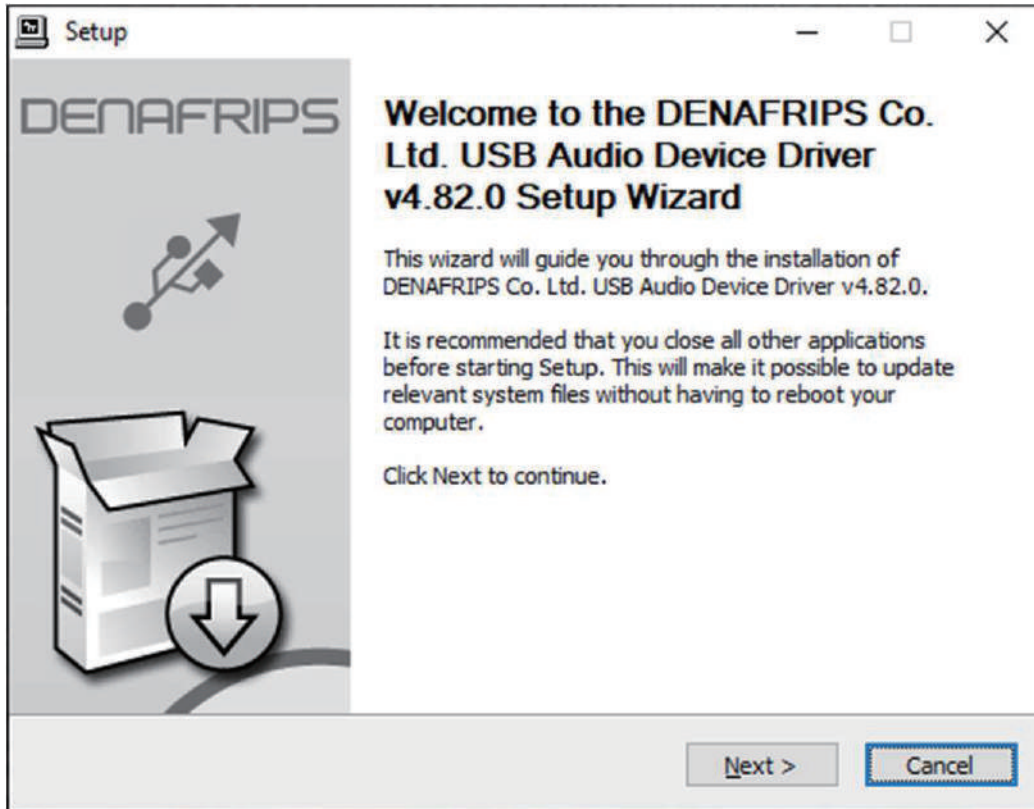

Figure 3. Welcome screen

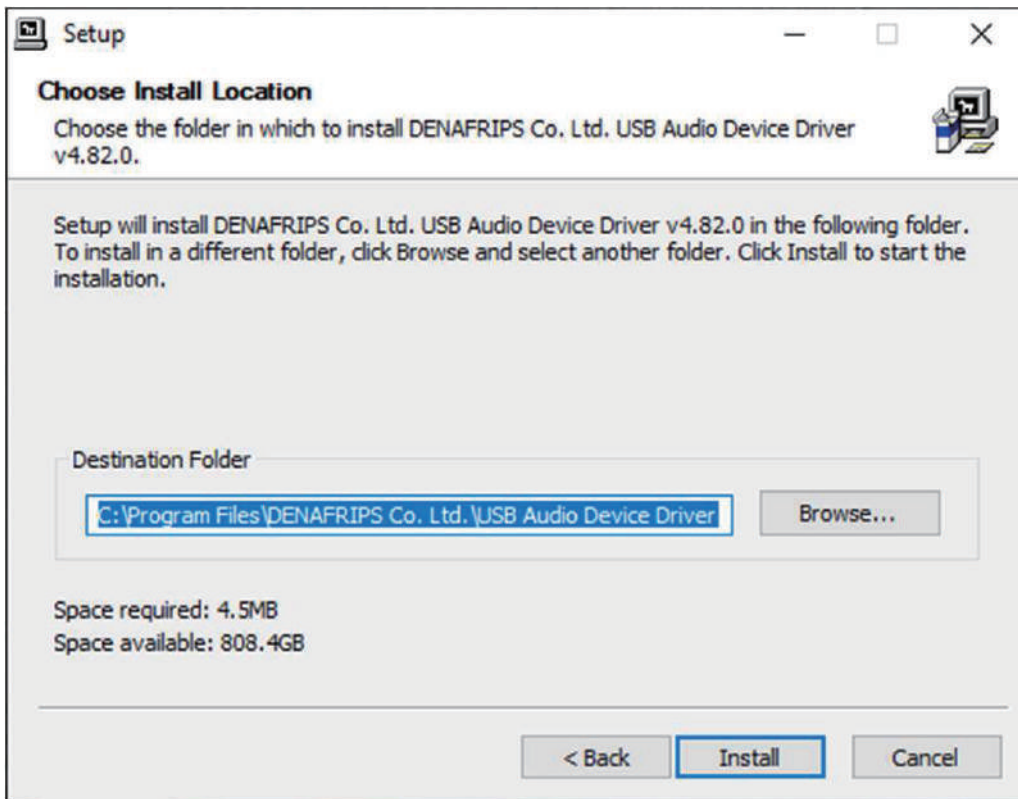

Figure 4. Default Installation Directory

OPERATING INSTRUCTION

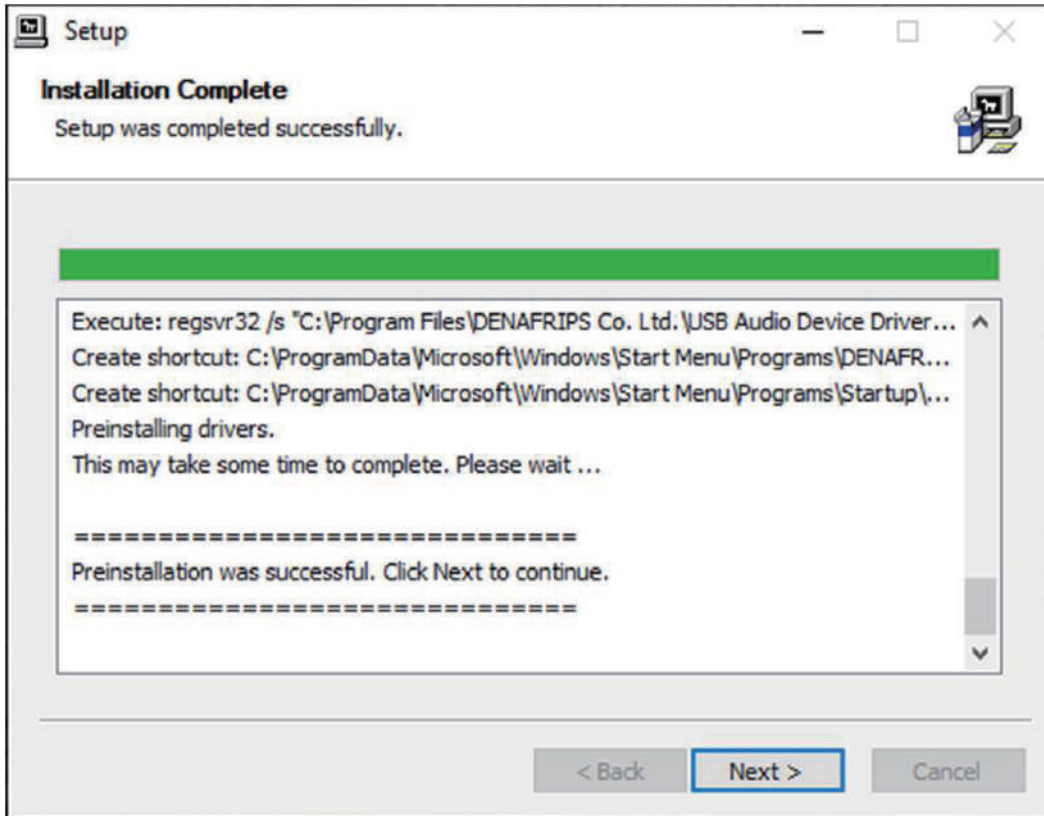

Figure 5. Preinstallation Successful

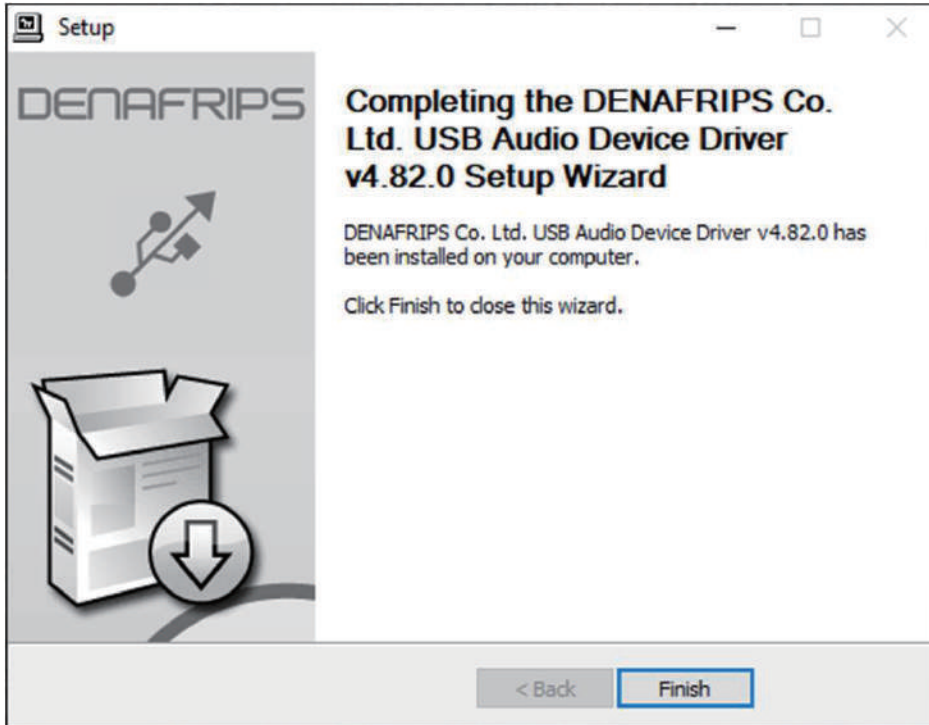

Figure 6. Completed

OPERATING INSTRUCTION

- Restart the computer to complete the installation
- Connect the USB cable to the DDC
- Power on the DDC. Select USB input
- The USB DDC shall be detected. The driver status can be monitored as follows

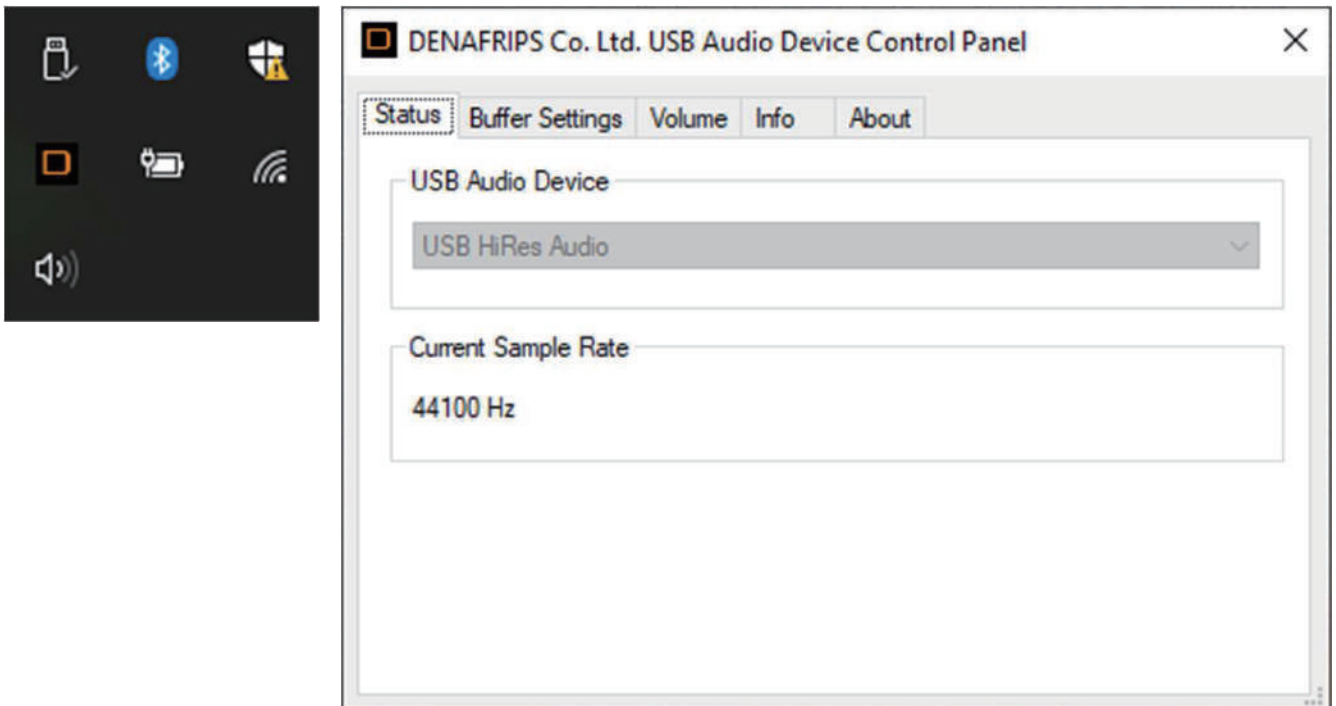
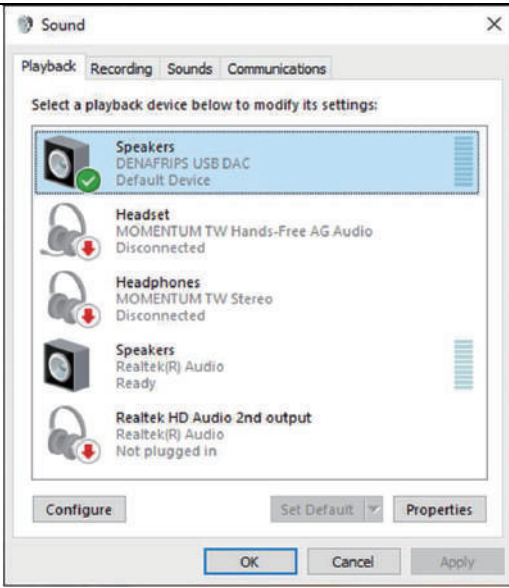
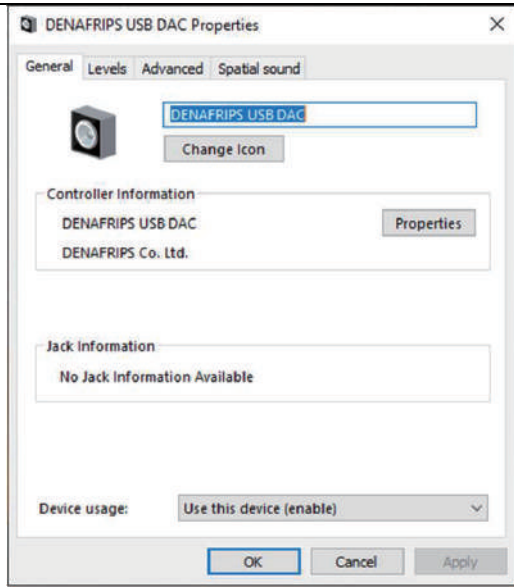
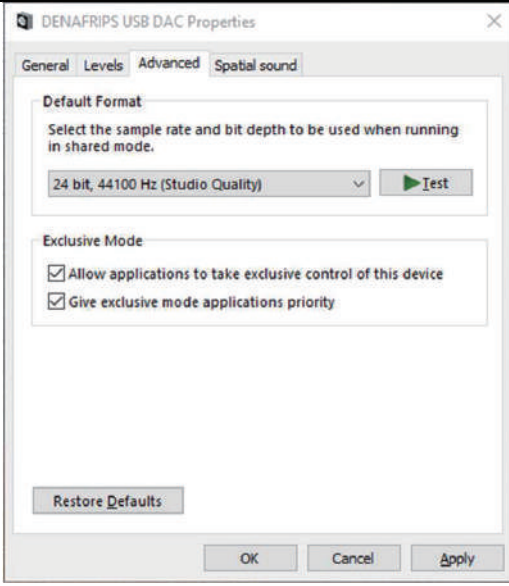
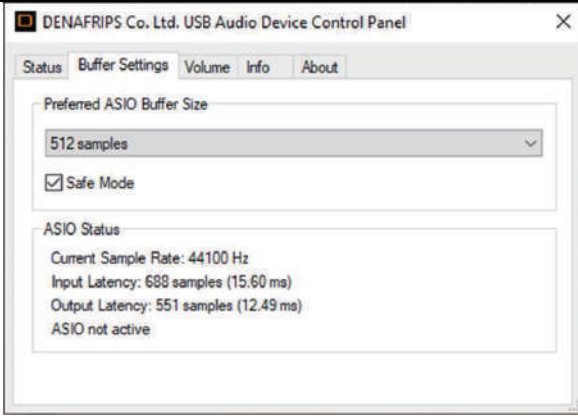

Figure 7. Taskbar & Control Panel

OPERATING INSTRUCTION

Select DENAFRIPS USB DDC as default Windows OS Soundcard

	
<p>Press Set Default button</p>	<p>Properties of the DENAFRIPS USB DDC</p>
	
<p>Direct-Sound default format</p>	<p>ASIO Buffer Size</p>

Playback software recommendation:

- roon
- JRiver
- Foobar2000
- Sonicstudio Amarra

SPECIFICATIONS

Description	Parameters
AC Power	Worldwide AC Power Supported 115 – 230V, 50/60Hz
	In 115VAC mains, the min voltage ranges from 92V to max 126V
	In 230VAC mains, the min voltage ranges from 184V to max 253V
Power Consumption	< 30W
Digital Input	Coax SPDIF via RCA OPT x 1 AES/EBU x 1 USB
External Clock Input	45.1584MHz 49.152MHz

SPECIFICATIONS

Description	Parameters
Digital Output	Coax SPDIF via RCA OPT x 1 AES/EBU x 2 I2S HDMI LVDS Standard I2S RJ45 LVCMOS Standard
Supported Format (DSD)	DSD64 All Input DSD64 – DSD512 USB & I2S Only
Supported Format (PCM)	24bit/44.1, 48, 88.2, 96, 176.4, 192 kHz All Input 44.1 – 768 kHz on USB & 44.1 – 384kHz on I2S Only
Dimensions	326W * 254D * 60H mm (including feet)
Packaging dimensions	485*342*150
Net weight	4.35kg
Gross weight	6.0kg

After-Sales Service

1. Thank you very much for choosing DENAFRIPS products. This product comes with a one-year free warranty. During the warranty period, if the product malfunctions due to non-human factors, we will provide free repair or replacement services. Please provide the serial number on the warranty card when contacting customer support.

1. Within Warranty Period: Within one year from the date of purchase, under normal use and non-human damage, if there are any product quality or functional issues.

Learn More: <https://www.denafrips.com/blank-6>

DENAFRIPS provides free repair or replacement of parts and covers the round-trip shipping costs.

2. Within the Warranty Period: Within one year from the date of purchase, if any product quality or functional issues occur due to human-caused damage.

The specific charges will be determined based on the actual fault and the cost of replacing parts. Please contact our after-sales service center for a detailed repair quote. The customer is responsible for the round-trip shipping costs.

3. After the Warranty Period: Paid repair service will be available after the warranty period expires. We will continue to provide repair services for a fee.

Specific charges will be determined based on the actual fault condition and the cost of replacement parts. Please contact our after-sales service center for a detailed repair quote. The customer is responsible for the round-trip shipping costs.

After-Sales Service

2. The product will not be eligible for free warranty service under any of the following conditions:
 - a. The product has exceeded the specified warranty period from the date of purchase.
 - b. The product does not match the model, barcode, or purchase date listed on the warranty card.
 - c. Unauthorized modification or repair of circuits or components by anyone other than DENAFRIPS technicians.
 - d. Damage caused by human factors (such as dropping, impact, water exposure, fire, etc.).
 - e. Damage caused by irresistible natural forces (such as earthquakes, floods, lightning strikes, etc.).
 - f. Damage caused by exceeding the allowed operating environment.
 - g. Damage caused by improper use or storage (including but not limited to: circuit or component burnout due to excessive voltage; damage to the casing or internal components due to impact; damage caused by excessive dust; product oxidation or corrosion, etc.).

3. This warranty policy applies only to customers who purchase products from the official website. For products purchased from distributors, the warranty terms will be governed by the warranty policy established by the seller.

DENAFRIPS

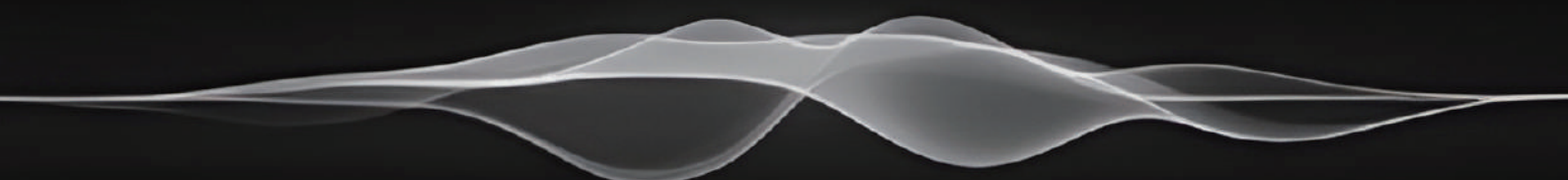

Phone: 020-84923054

Email: support@denafrips.com

Official Website: <https://www.denafrips.com/>

