

DENAFRIPS

IRIS DDC

OWNER'S MANUAL

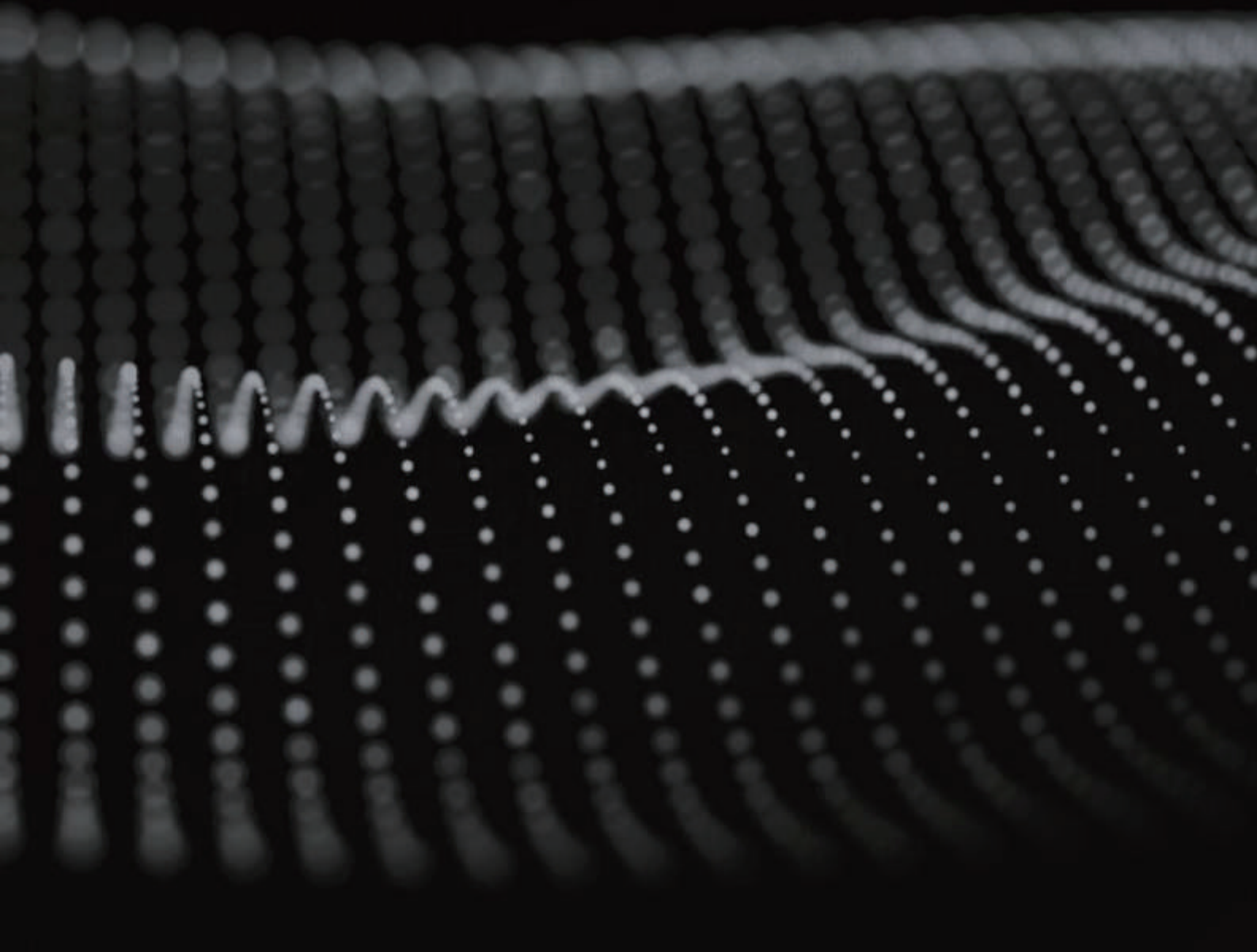

INSTALLATION & SAFETY INSTRUCTIONS

Contents

1. INSTALLATION & SAFETY INSTRUCTIONS	3
2. INTRODUCTION	5
3. DESIGN HIGHLIGHTS	6
3.1 DIGITAL ISOLATION	6
3.2 TEMPERATURE-COMPENSATED CRYSTAL OSCILLATOR – TCXO ..	6
3.3 ADAPTIVE FIFO BUFFER RECLOCKING	6
3.4 PROPRIETARY, STATE-OF-THE-ART USB INTERFACE.....	7
3.5 DDC ARCHITECTURE.....	7
3.6 CLOCK IN.....	8
4. OPERATING INSTRUCTION	9
4.1 QUICK START GUIDE.....	9
4.2 USB DRIVER INSTALLATION – WINDOWS OS	14
5. SPECIFICATIONS	19
6. AFTER-SALES SERVICE	21

INSTALLATION & SAFETY INSTRUCTIONS

This DDC is designed and built to provide trouble-free performance, but as with all electronic devices it is necessary to observe a few precautions:

1. Unpack the IRIS DDC carefully.
2. Position the DDC on a stable, horizontal surface, i.e. sturdy rack.
3. The DDC supports voltage 115–230VAC worldwide voltage. Please connect the AC power cord with earth(ground) pin unless it is absolutely required to reduce hum from the ground loops of the connected devices.
4. Always ensure that when disconnecting and reconnecting your audio equipment the mains supply is turned off.
5. Position the power cord and signal interconnects where they are not likely cause trip and fall hazard.
6. Do not use the Equipment near water, or place water-filled containers on the Equipment. Entry of liquid into the Equipment is hazardous and may cause electric shock and/or fire hazard.
7. Do not place the unit under direct sunlight or heat source.
8. Do not remove any covers or try to gain access to the inside. There are no user adjustments or fuses to change without qualification.

INSTALLATION & SAFETY INSTRUCTIONS

9. Clean regularly with a damp soft cloth. Do not use any cleaning agents as it might damage the surface finishing.
10. The electronics in modern hi-fi equipment is complex and may, therefore, be adversely affected or damaged by lightning. For protection of the audio system during electrical storms, disconnect the mains plugs.

INTRODUCTION

Thank you for purchasing the DENAFRIPS IRIS DDC.

The entry DDC, built upon the success of the DENAFRIPS Digital Know-How. IRIS DDC isolates and buffers the USB input data, re-clock them via the local FEMTO Crystal Oscillators. The cleansed, ultra-low jitters digital output can be connected to any external DAC.

It transforms the Computer Audio System into a high-quality transport. The sonic improvement is evident as soon as the IRIS DDC is added into the Digital Audio chain.



DESIGN HIGHLIGHTS

3.1 DIGITAL ISOLATION

The IRIS Digital Signals are completely isolated by the 50-Mbps high speed photocouplers. The optical isolation yields even lowered noise-floor and achieved high signal to noise ratio.

3.2 Temperature-Compensated Crystal Oscillator – TCXO

The IRIS is equipped with dual TCXO operating at audio frequencies 45.1584MHz, 49.152MHz. Encapsulated in a metal casing, located at the centre of the DDC, these TCXO are specially designed for high-end audio applications with ultra-low phase-noise and ultraaccuracy. The dual TCXO are powered by the o-core transformer, supplying constant current to the TCXO. The adequate power reserves ensure the superior linearity and stability of the TCXO.

3.3 ADAPTIVE FIFO BUFFER RECLOCKING

The DENAFRIPS approach to address the jitters issue by FIFO BUFFER RECLOCKING. The adaptive FIFO buffer store the source digital audio data in the memory. These data are read from the memory using the FEMTO CLOCK, located right in the DDC.

DESIGN HIGHLIGHTS

3.4 PROPRIETARY, STATE-OF-THE-ART USB INTERFACE

The IRIS is equipped with the proprietary USB Audio Solution, powered by STM32F446 Advanced AMR Based MCU. DENAFRIPS redesigned and optimized circuitry, allow the DDC to be used as high-end DDC with computers / streamers. It supports 24bit/768kHz PCM data stream, and native processing of DSD up to DSD1024. It comes with licensed THESYCON USB Driver for Windows Platform.

NOTE: The USB Module is designed to trigger on only when USB Input is selected. This is intended design to reduce digital input interfaces cross-interference for best sound reproduction.

3.5 DDC ARCHITECTURE

DIGITAL SIGNAL PROCESSING – All digital input data are stored in the on-board FPGA high speed RAM.

TCXO – These data are read from the memory using the ultra-low phase noise, super accurate TCXO, located right in the DDC. The processed data are sent to the digital outputs.

DIGITAL OUTPUTS – The cleansed, ultra-low jitters data are output via multiple digital output interfaces simultaneously to the external DAC.

DESIGN HIGHLIGHTS

3.6 CLOCK IN

The IRIS supports clock in of audio frequencies 45.1584MHz, 49.152MHz. It makes a perfect companion with the TERMINATOR 15TH or TERMINATOR-PLUS 15TH to synchronize the CLOCKS.

OPERATING INSTRUCTION

4.1 Quick Start Guide



Figure 1. Front Panel

(1) Standby Button

Press the setup button once to enable/disable the CLOCK-IN feature.

- Press Setup button once
- CLOCK light should be on/off as the Setup button is pressed momentarily
- CLOCK light on = Enable CLOCK in
- CLOCK light off = Disable CLOCK in

OPERATING INSTRUCTION

(2) Digital Audio Signal Input Sampling Rate

The following table illustrate the Input Sampling Rate LED status.

Base Sampling Rate	Indicator	Input Format
44.1 KHz	44.1K	44.1 KHz
	88.2K	88.2 KHz
	176.4K	176.4 KHz
	352.8K	352.8 KHz
	705.6K	705.6 KHz
48 KHz	48K	48 KHz
	96K	96 KHz
	192K	192 KHz
	384K	384 KHz
	768K	768 KHz
DSD	64	DSD 64
	128	DSD 128
	256	DSD 256
	512	DSD 512
	1024	DSD 1024

Table 1. Sampling Rate

OPERATING INSTRUCTION



Figure 2. Read Panel

Description:

(1) AC Power Supply

CAUTION! IRIS supports AC mains range from 115–230VAC. Please check the voltage switch underneath the DDC, switch it to the correct voltage before connecting the AC mains.

(2) Digital Input Interface

IRIS support USB input only.

(3) Digital Output Interface

There are 6 Digital Output Interfaces, namely, COAX, AES, OPT, I2S–A, I2S–C. All outputs are active simultaneously.

OPERATING INSTRUCTION

I2S-A HDMI (LVDS)

I2S-C RJ45 (LVCMOS)

I2S-A I2S(HDMI端子)

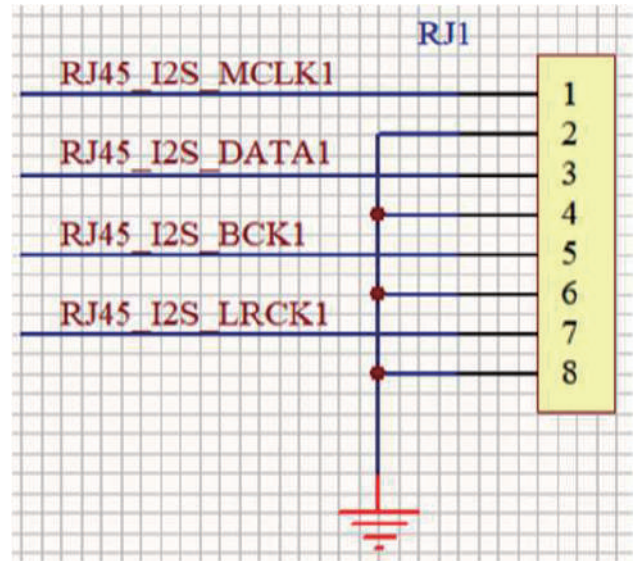
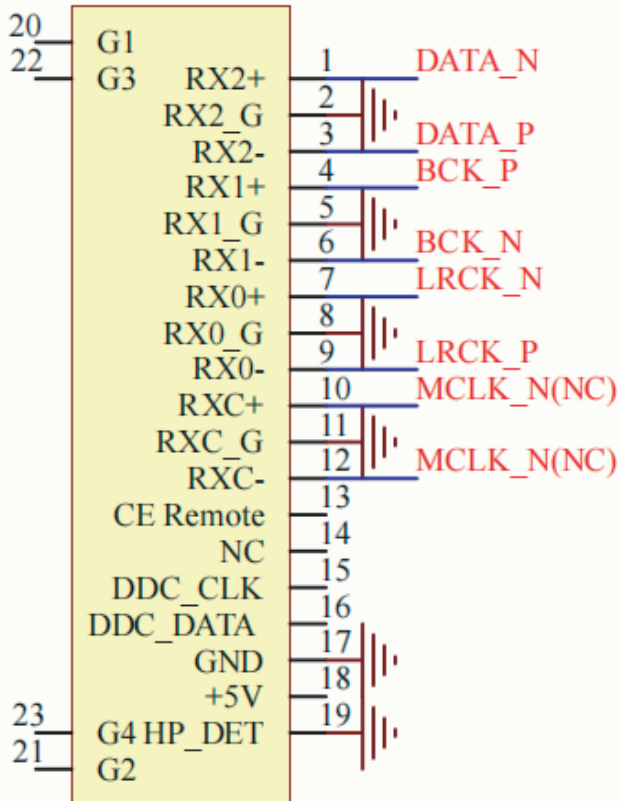

OPERATING INSTRUCTION

(4) CLOCK IN

The IRIS supports the following clock frequencies input, leveraging the high-quality TCXO of the TERMINATOR 15TH or TERMINATOR-PLUS 15TH DAC, it may be connected to IRIS CLOCK-IN to improve the sonic performance.

MASTER CLOCK

- 45.1584MHz, 49.152MHz

Use Case Example:

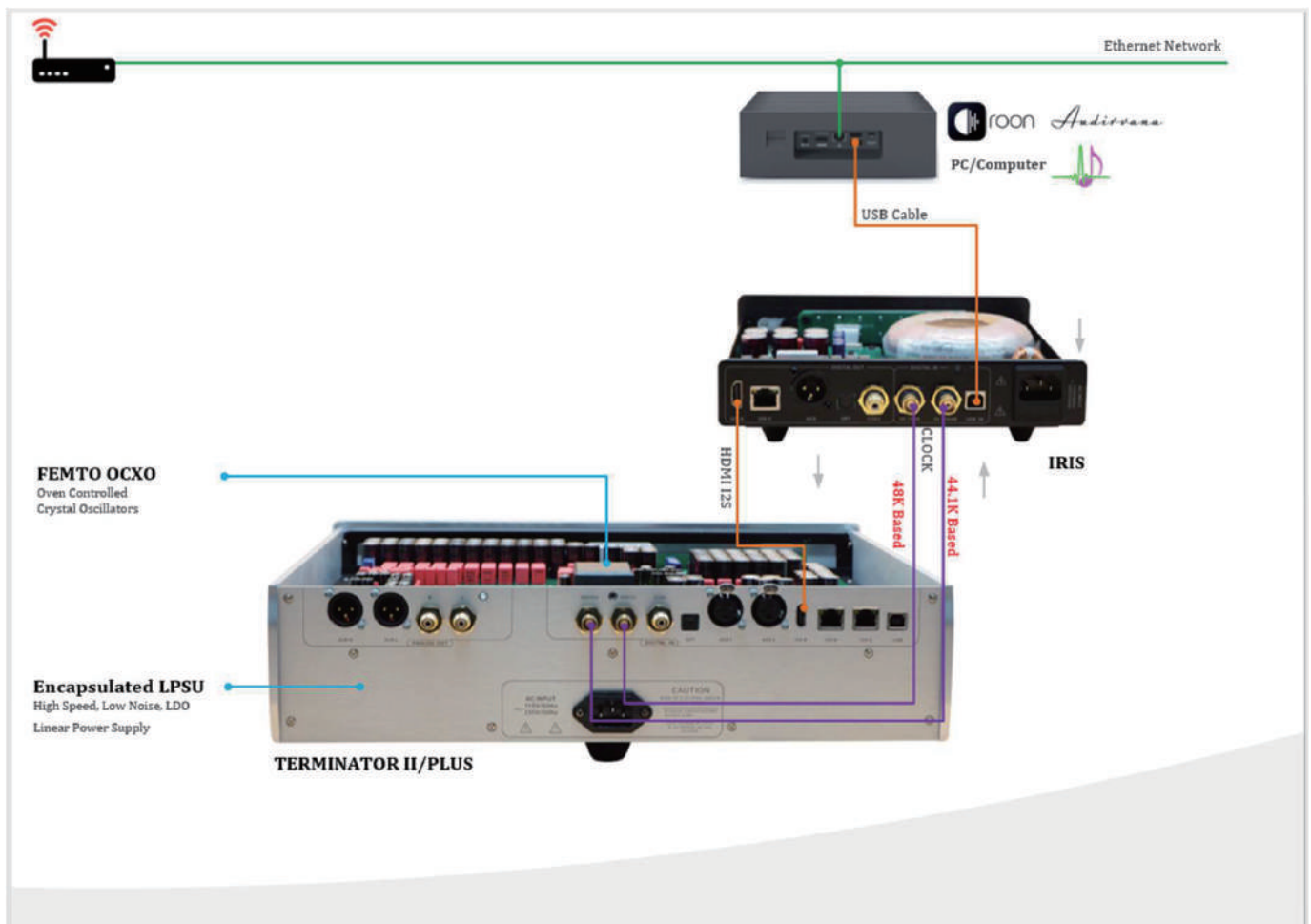

Table 3. Use case examples of IRIS CLOCK IN

OPERATING INSTRUCTION

4.2 USB DRIVER INSTALLATION –WINDOWS OS

USB driver is required for Windows Operating System (Windows 7/8/8.1/10, X86/X64). The USB driver is licensed by THESYCON to provide the highest quality audio playback for Computer Audio System.

NOTE: Mac and Linux OS do not require the USB driver.

Installation Guide:

1.Download the driver from the support page:

<https://www.denafrips.com/support>

2.Do not connect the USB cable from the computer to the DDC. Remove it before the USB driver installation

3.Double click the “DENAFRIPS_UsbAudio_v4.82.0” (or the latest version) to install the USB driver.

4.Follow the on–screen instruction to complete the installation

OPERATING INSTRUCTION

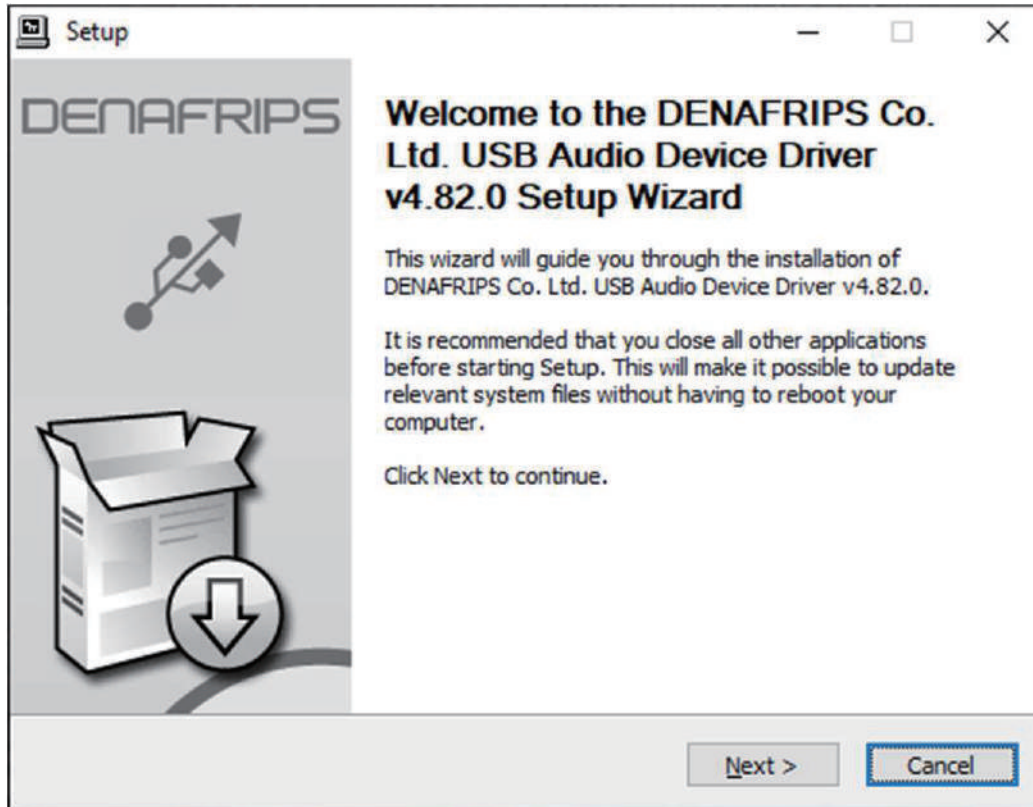

Figure 3. Welcome screen

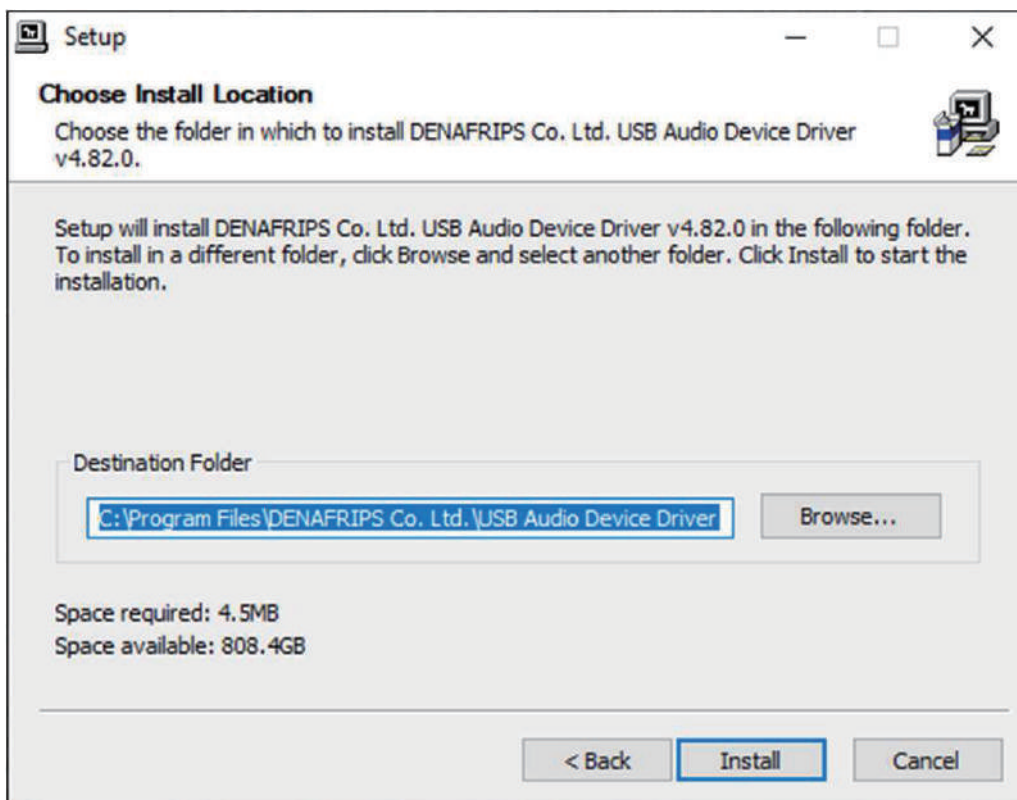

Figure 4. Default Installation Directory

OPERATING INSTRUCTION

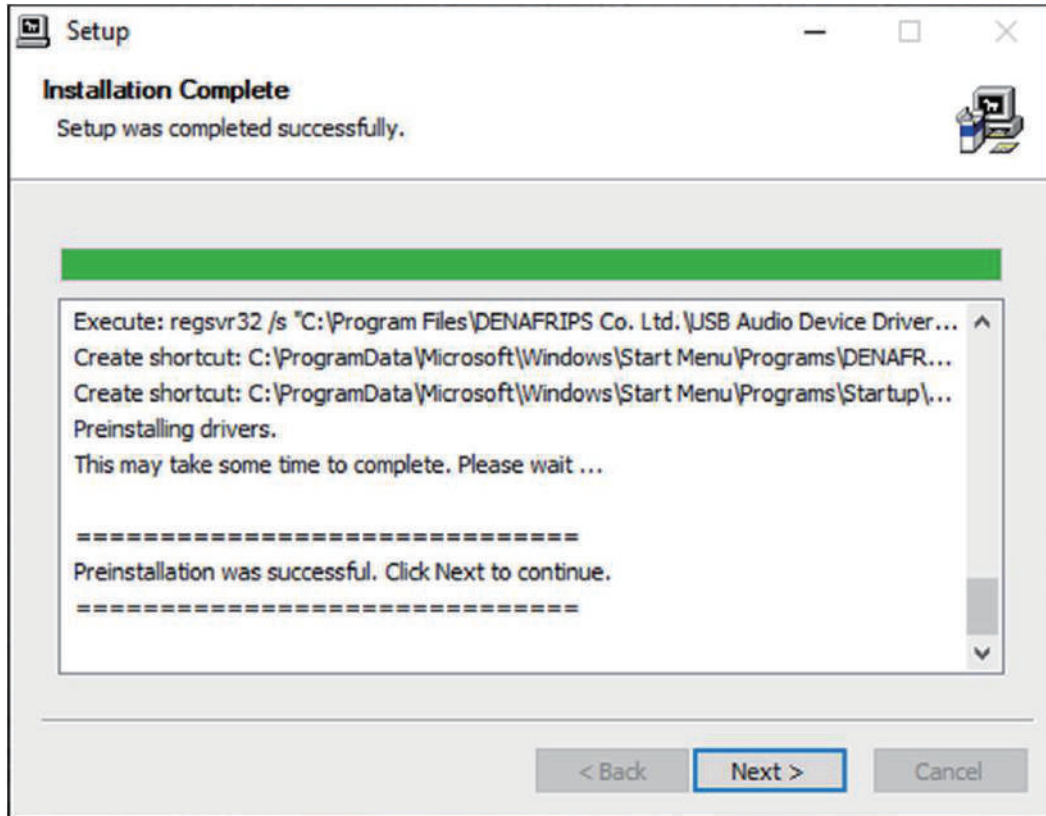

Figure 5. Preinstallation Successful

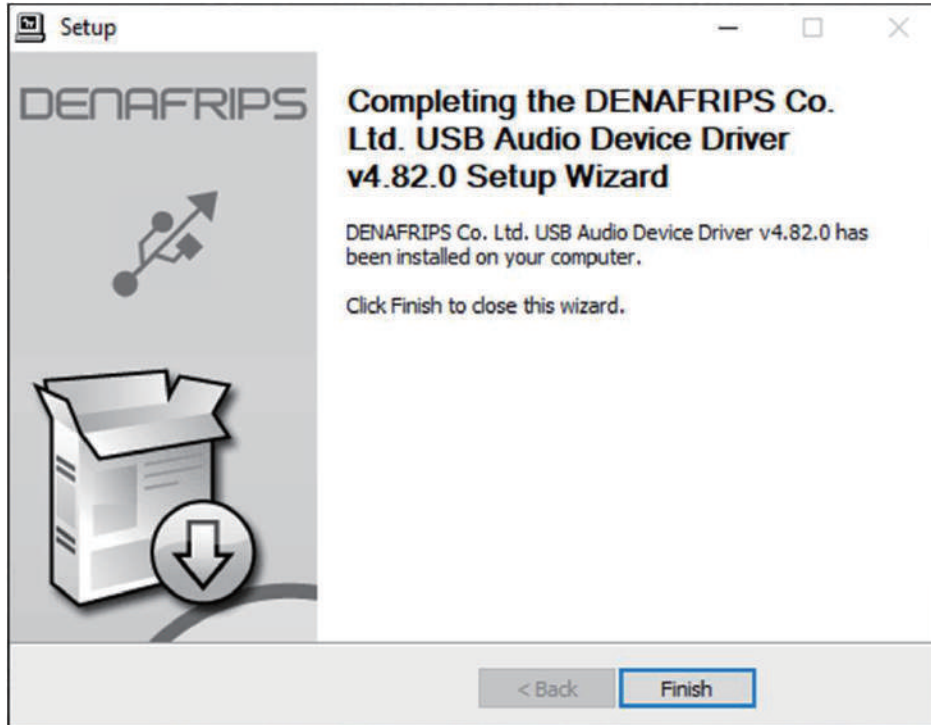

Figure 6. Completed

OPERATING INSTRUCTION

- Restart the computer to complete the installation
- Connect the USB cable to the DDC
- Power on the DDC. Select USB input
- The USB DDC shall be detected. The driver status can be monitored as follows

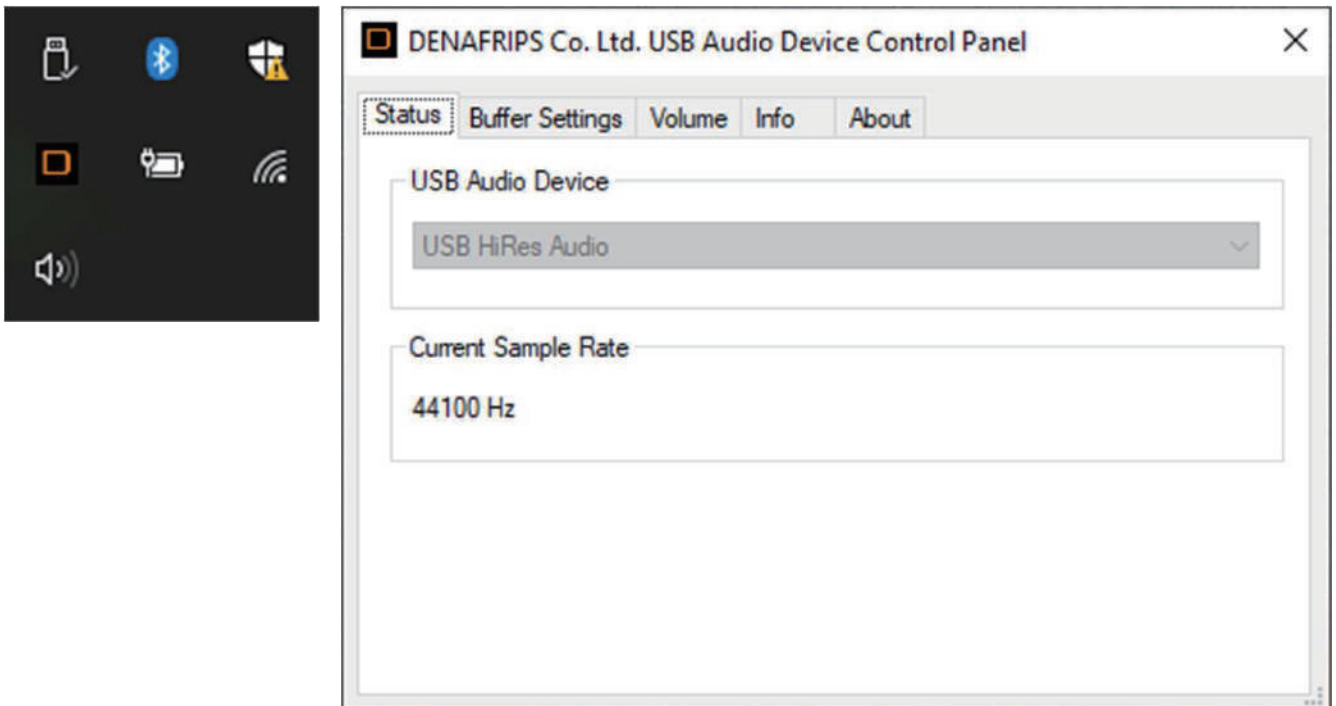
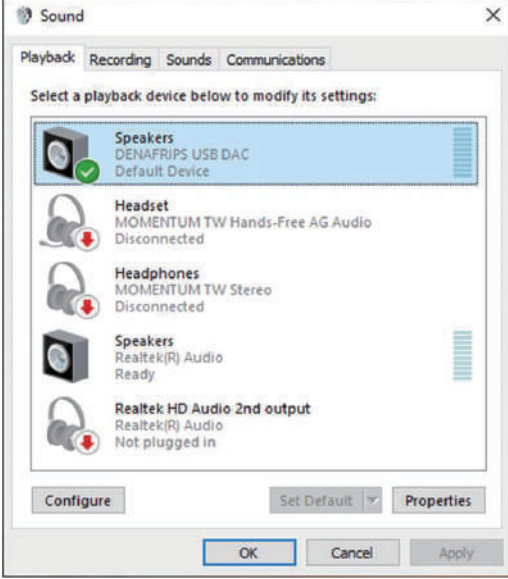
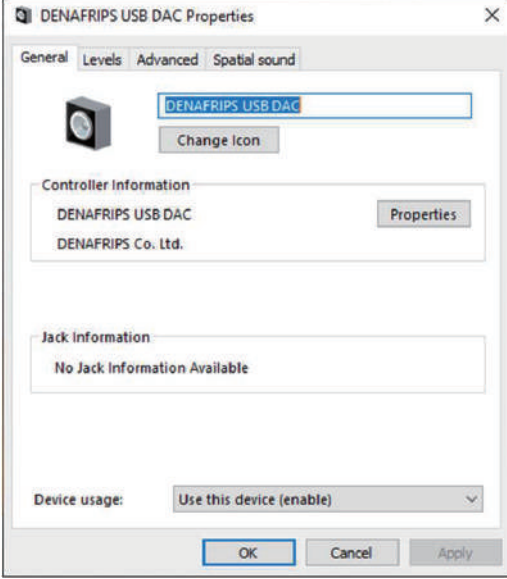
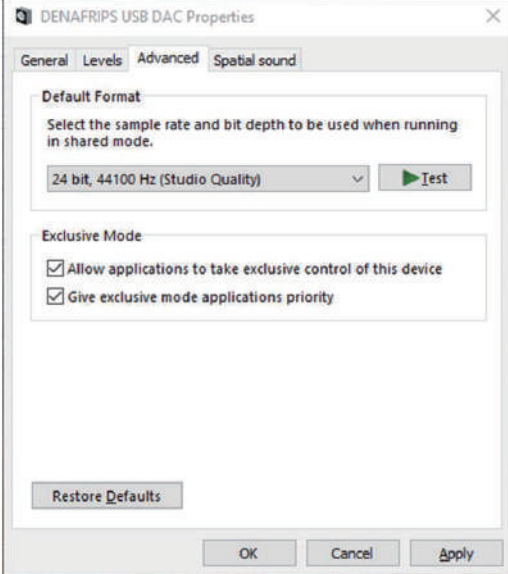
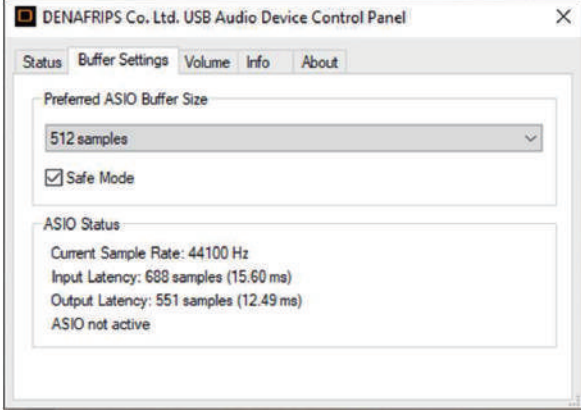

Figure 7. Taskbar & Control Panel

OPERATING INSTRUCTION

Select DENAFRIPS USB DDC as default Windows OS Soundcard

	
<p>Press Set Default button</p>	<p>Properties of the DENAFRIPS USB DDC</p>
	
<p>Direct-Sound default format</p>	<p>ASIO Buffer Size</p>

Playback software recommendation:

- roon
- JRiver
- Foobar2000
- Sonicstudio Amarra

SPECIFICATIONS

Description	Parameters
AC Power	115VAC or 230VAC
Power Consumption	< 20W
Digital Input	Coax SPDIF via RCA OPT x 1 AES/EBU x 1 I2S HDMI LVDS Standard I2S RJ45 LVCMOS Standard
Supported Format (DSD)	DSD64 All Input DSD64 – DSD512 USB & I2S Only

SPECIFICATIONS

Description	Parameters
Supported Format (PCM)	24bit/44.1, 48, 88.2, 96, 176.4, 192 kHz All Input 44.1 – 768 kHz on USB & 44.1 – 384kHz on I2S Only
Product Dimensions	220W*245D*60H mm (including feet)
Packaging Dimensions	380*325*120
Net Weight	3.35kg
Gross Weight	4.45kg

AFTER-SALES SERVICE

1. Thank you very much for choosing DENAFRIPS products. This product comes with a one-year free warranty. During the warranty period, if the product malfunctions due to non-human factors, we will provide free repair or replacement services. Please provide the serial number on the warranty card when contacting customer support.

1. Within Warranty Period: Within one year from the date of purchase, under normal use and non-human damage, if there are any product quality or functional issues.

Learn More: <https://www.denafrips.com/blank-6>

DENAFRIPS provides free repair or replacement of parts and covers the round-trip shipping costs.

2. Within the Warranty Period: Within one year from the date of purchase, if any product quality or functional issues occur due to human-caused damage.

The specific charges will be determined based on the actual fault and the cost of replacing parts. Please contact our after-sales service center for a detailed repair quote. The customer is responsible for the round-trip shipping costs.

3. After the Warranty Period: Paid repair service will be available after the warranty period expires. We will continue to provide repair services for a fee.

Specific charges will be determined based on the actual fault condition and the cost of replacement parts. Please contact our after-sales service center for a detailed repair quote. The customer is responsible for the round-trip shipping costs.

AFTER-SALES SERVICE

2. The product will not be eligible for free warranty service under any of the following conditions:
 - a. The product has exceeded the specified warranty period from the date of purchase.
 - b. The product does not match the model, barcode, or purchase date listed on the warranty card.
 - c. Unauthorized modification or repair of circuits or components by anyone other than DENAFRIPS technicians.
 - d. Damage caused by human factors (such as dropping, impact, water exposure, fire, etc.).
 - e. Damage caused by irresistible natural forces (such as earthquakes, floods, lightning strikes, etc.).
 - f. Damage caused by exceeding the allowed operating environment.
 - g. Damage caused by improper use or storage (including but not limited to: circuit or component burnout due to excessive voltage; damage to the casing or internal components due to impact; damage caused by excessive dust; product oxidation or corrosion, etc.).

3. This warranty policy applies only to customers who purchase products from the official website. For products purchased from distributors, the warranty terms will be governed by the warranty policy established by the seller.

DENAFRIPS

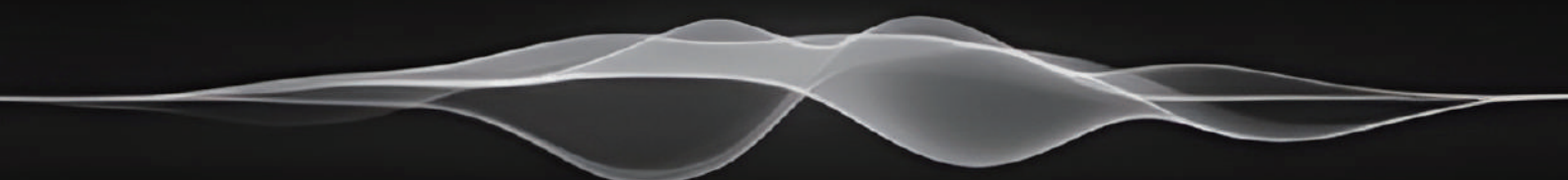

Phone: 020-84923054

Email: support@denafrips.com

Official Website: <https://www.denafrips.com/>

